

Part number:

HYDROMA

HYDRAULICKÉ SYSTÉMY

**HIDROMA
SYSTEMS**

UKŁADY HYDRAULICZNE

HYDROMA

ГИДРАВЛИЧЕСКИЕ СИСТЕМЫ

SPARE PARTS LIST FOR VANE PUMPS

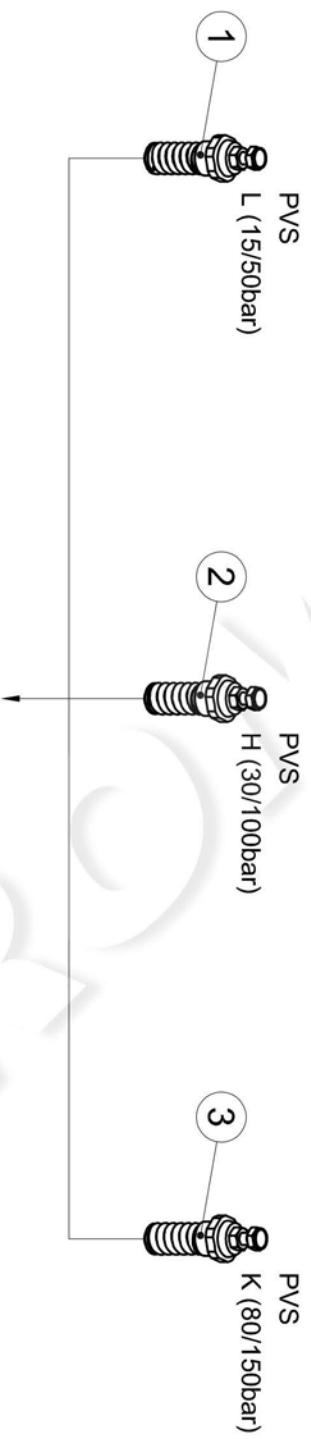

| N | CODICE / CODE |
|---|---------------|
| 1 | 3001005000 |
| 2 | 3001005100 |
| 3 | 3001005200 |

In Fase Di Ordine E' Necessario Indicare La Descrizione Completa Della Pompa Sulla Quale Il Compensatore Verrà Montato.
 In Phase Of Order You Must Indicate The Complete Code Of The Pump On Which The Compensator Is Mounted.

COMPENSATORI INTERCambiabili
 INTERCHANGEABLE COMPENSATORS

POMPA
 PUMP

02 PVS 05

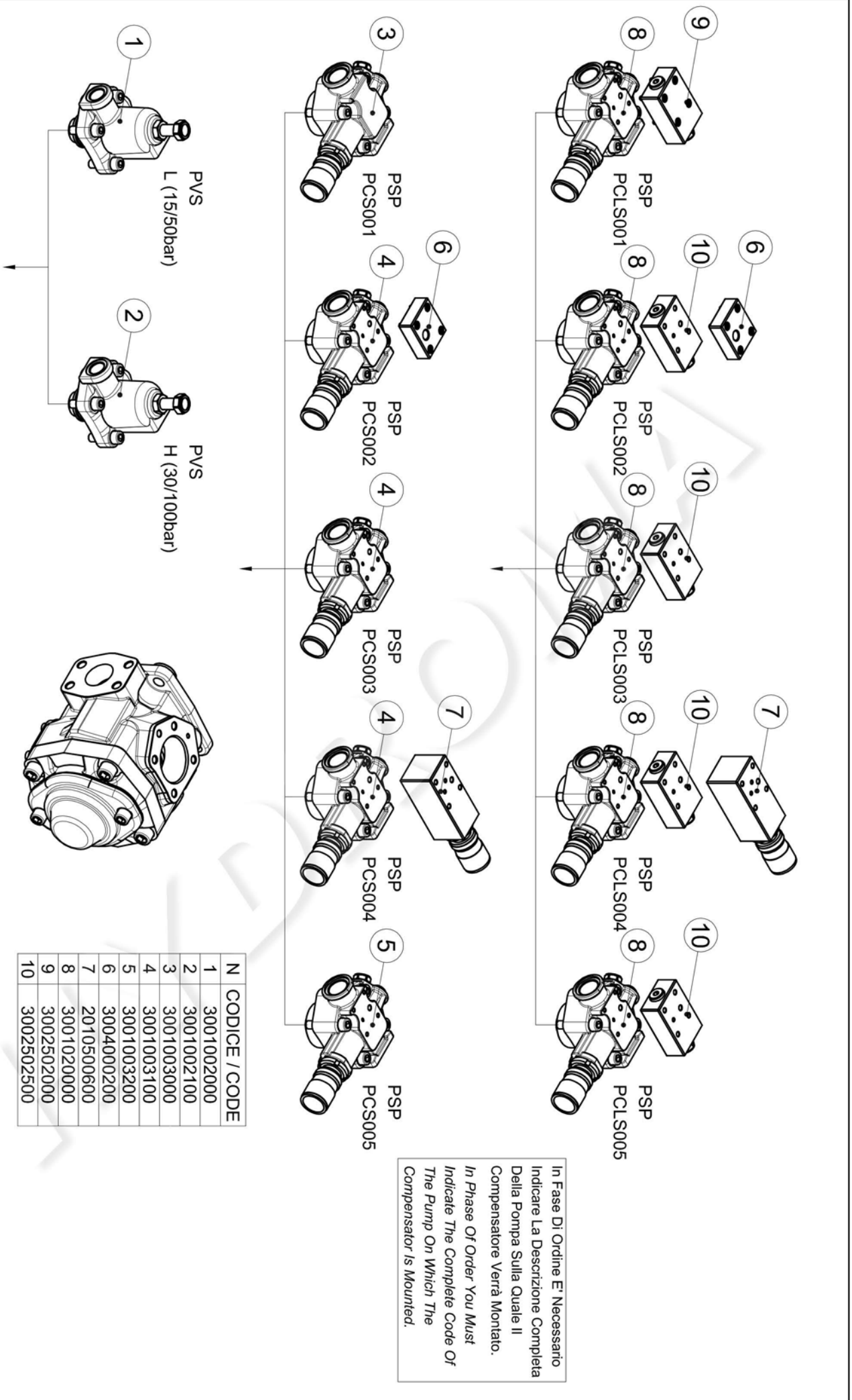

In Fase Di Ordine E' Necessario Indicare La Descrizione Completa Della Pompa Sulla Quale Il Compensatore Verrà Montato.
 In Phase Of Order You Must Indicate The Complete Code Of The Pump On Which The Compensator Is Mounted.

| N | CODICE / CODE |
|----|---------------|
| 1 | 3001002000 |
| 2 | 3001002100 |
| 3 | 3001003000 |
| 4 | 3001003100 |
| 5 | 3001003200 |
| 6 | 3004000200 |
| 7 | 2010500600 |
| 8 | 3001020000 |
| 9 | 3002502000 |
| 10 | 3002502500 |

COMPENSATORI INTERCambiabili
 INTERCHANGEABLE COMPENSATORS

POMPA
 PUMP

02 PVS PSP 2

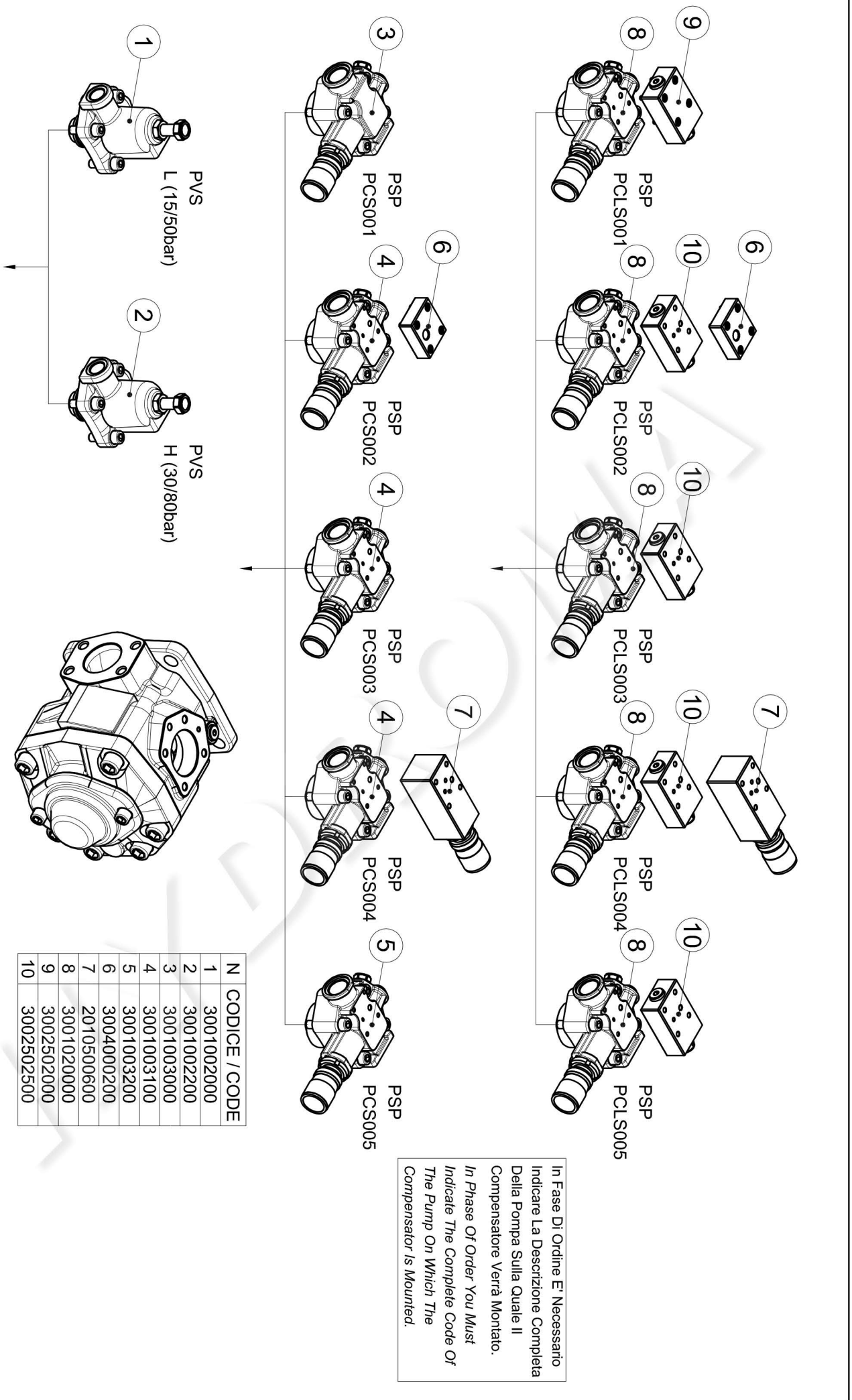

In Fase Di Ordine E' Necessario Indicare La Descrizione Completa Della Pompa Sulla Quale Il Compensatore Verrà Montato.
 In Phase Of Order You Must Indicate The Complete Code Of The Pump On Which The Compensator Is Mounted.

| N | CODICE / CODE |
|----|---------------|
| 1 | 3001002000 |
| 2 | 3001002200 |
| 3 | 3001003000 |
| 4 | 3001003100 |
| 5 | 3001003200 |
| 6 | 3004000200 |
| 7 | 2010500600 |
| 8 | 3001020000 |
| 9 | 3002502000 |
| 10 | 3002502500 |

COMPENSATORI INTERCambiabili
 INTERCHANGEABLE COMPENSATORS

POMPA
 PUMP

02 PVS PSP 3

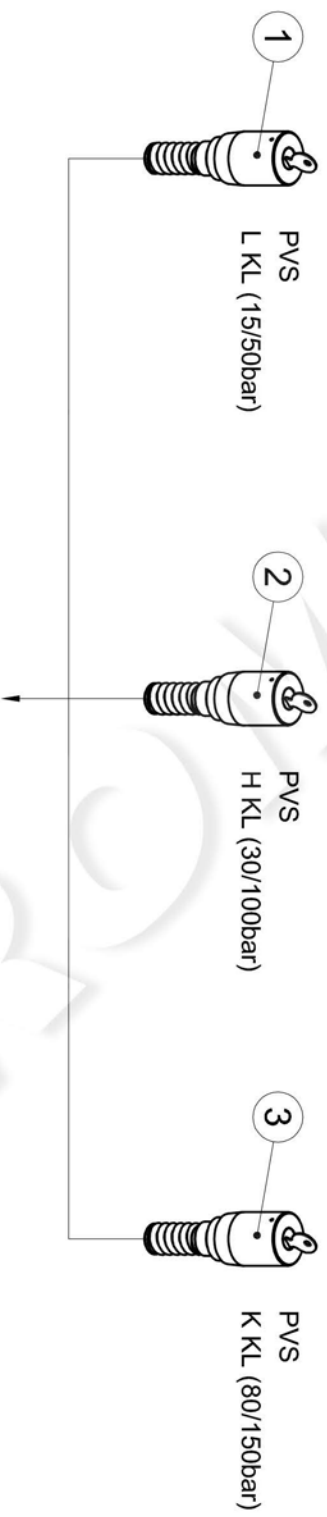

| N | CODICE / CODE |
|---|---------------|
| 1 | 3001055000 |
| 2 | 3001055100 |
| 3 | 3001055200 |

In Fase Di Ordine E' Necessario Indicare La Descrizione Completa Della Pompa Sulla Quale Il Compensatore Verrà Montato.
 In Phase Of Order You Must Indicate The Complete Code Of The Pump On Which The Compensator Is Mounted.

COMPENSATORI KEY LOCK INTERCambiabili
 INTERCHANGEABLE KEY LOCK COMPENSATORS

POMPA
 PUMP

02 PVS 05

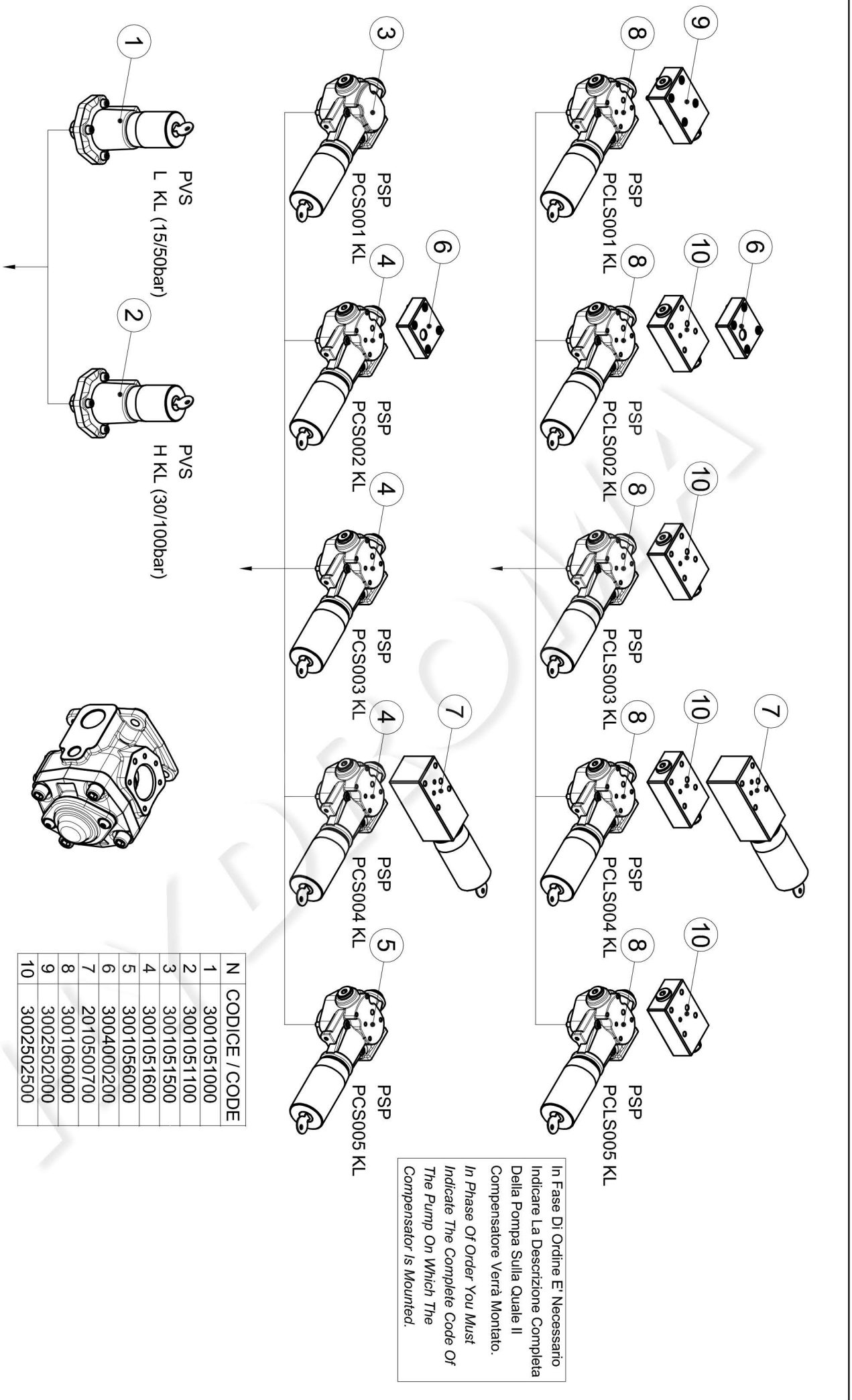

In Fase Di Ordine E' Necessario Indicare La Descrizione Completa Della Pompa Sulla Quale Il Compensatore Verrà Montato.
 In Phase Of Order You Must Indicate The Complete Code Of The Pump On Which The Compensator Is Mounted.

| N | CODICE / CODE |
|----|---------------|
| 1 | 3001051000 |
| 2 | 3001051100 |
| 3 | 3001051500 |
| 4 | 3001051600 |
| 5 | 3001056000 |
| 6 | 3004000200 |
| 7 | 2010500700 |
| 8 | 3001060000 |
| 9 | 3002502000 |
| 10 | 3002502500 |

COMPENSATORI KEY LOCK INTERCambiabili
INTERCHANGEABLE KEY LOCK COMPENSATORS

POMPA
PUMP

02 PVS PSP 1

PVS
 L KL (15/50bar)

PVS
 H KL (30/100bar)

PSP
 PCS001 KL

PSP
 PCS002 KL

PSP
 PCS003 KL

PSP
 PCS004 KL

PSP
 PCS005 KL

PSP
 PCLS001 KL

PSP
 PCLS002 KL

PSP
 PCLS003 KL

PSP
 PCLS004 KL

PSP
 PCLS005 KL

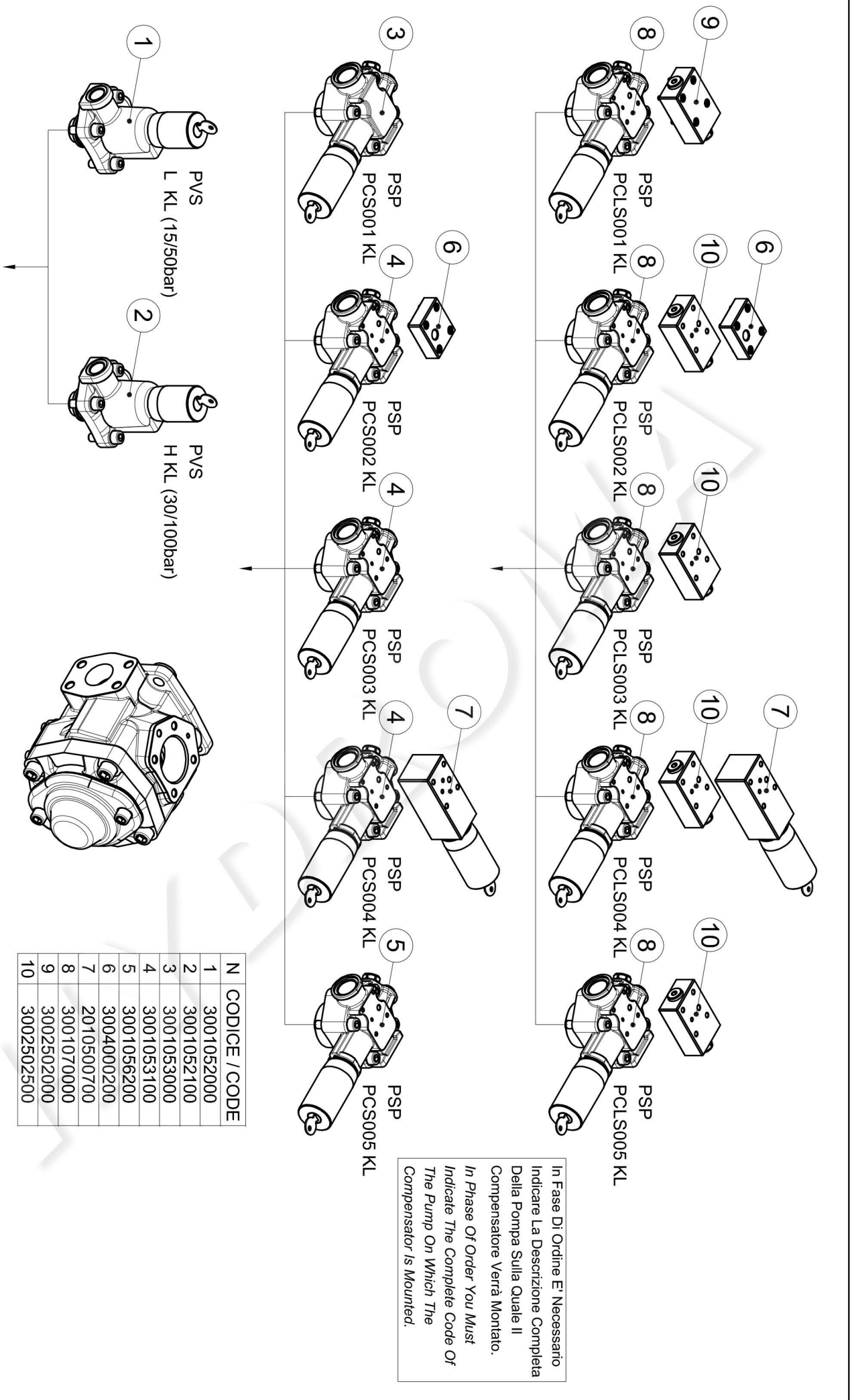

In Fase Di Ordine E' Necessario Indicare La Descrizione Completa Della Pompa Sulla Quale Il Compensatore Verrà Montato.
 In Phase Of Order You Must Indicate The Complete Code Of The Pump On Which The Compensator Is Mounted.

| N | CODICE / CODE |
|----|---------------|
| 1 | 3001052000 |
| 2 | 3001052100 |
| 3 | 3001053000 |
| 4 | 3001053100 |
| 5 | 3001056200 |
| 6 | 3004000200 |
| 7 | 2010500700 |
| 8 | 3001070000 |
| 9 | 3002502000 |
| 10 | 3002502500 |

COMPENSATORI KEY LOCK INTERCambiabili
 INTERCHANGEABLE KEY LOCK COMPENSATORS

POMPA
 PUMP

02 PVS PSP 2

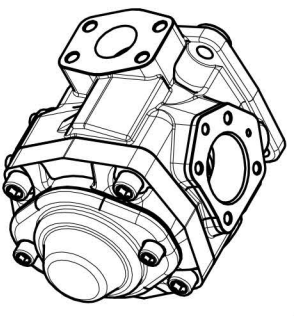
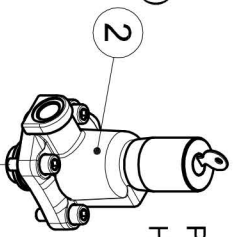
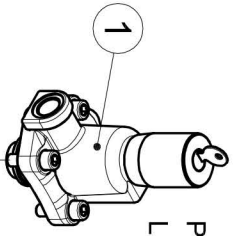

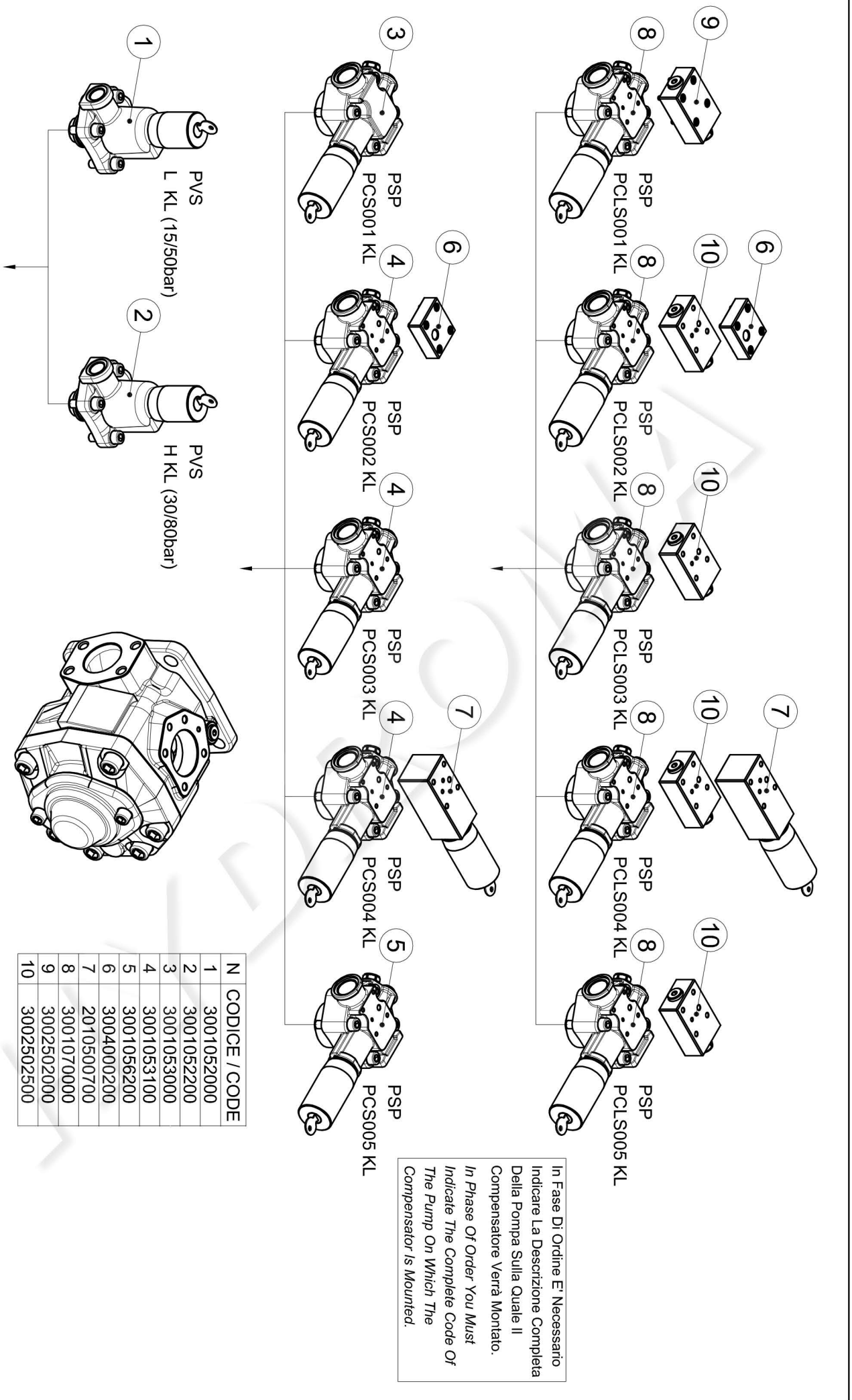

In Fase Di Ordine E' Necessario Indicare La Descrizione Completa Della Pompa Sulla Quale Il Compensatore Verrà Montato. In Phase Of Order You Must Indicate The Complete Code Of The Pump On Which The Compensator Is Mounted.

| N | CODICE / CODE |
|----|---------------|
| 1 | 3001052000 |
| 2 | 3001052200 |
| 3 | 3001053000 |
| 4 | 3001053100 |
| 5 | 3001056200 |
| 6 | 3004000200 |
| 7 | 2010500700 |
| 8 | 3001070000 |
| 9 | 3002502000 |
| 10 | 3002502500 |

COMPENSATORI KEY LOCK INTERCambiabili
 INTERCHANGEABLE KEY LOCK COMPENSATORS

POMPA
 PUMP
 02 PVS PSP 3

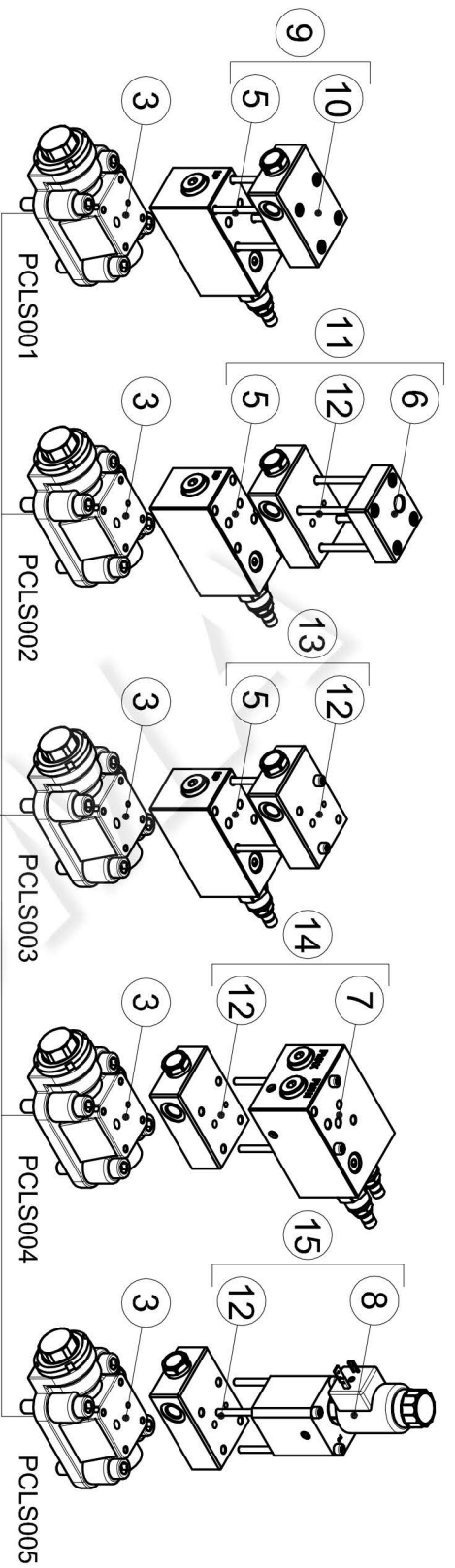

In Fase Di Ordine E' Necessario Indicare La Descrizione Completa Della Pompa Sulla Quale Il Compensatore Verrà Montato.
 In Phase Of Order You Must Indicate The Complete Code Of The Pump On Which The Compensator Is Mounted.

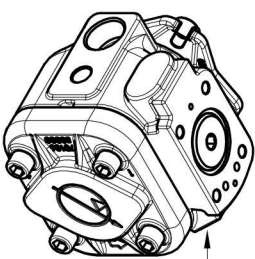
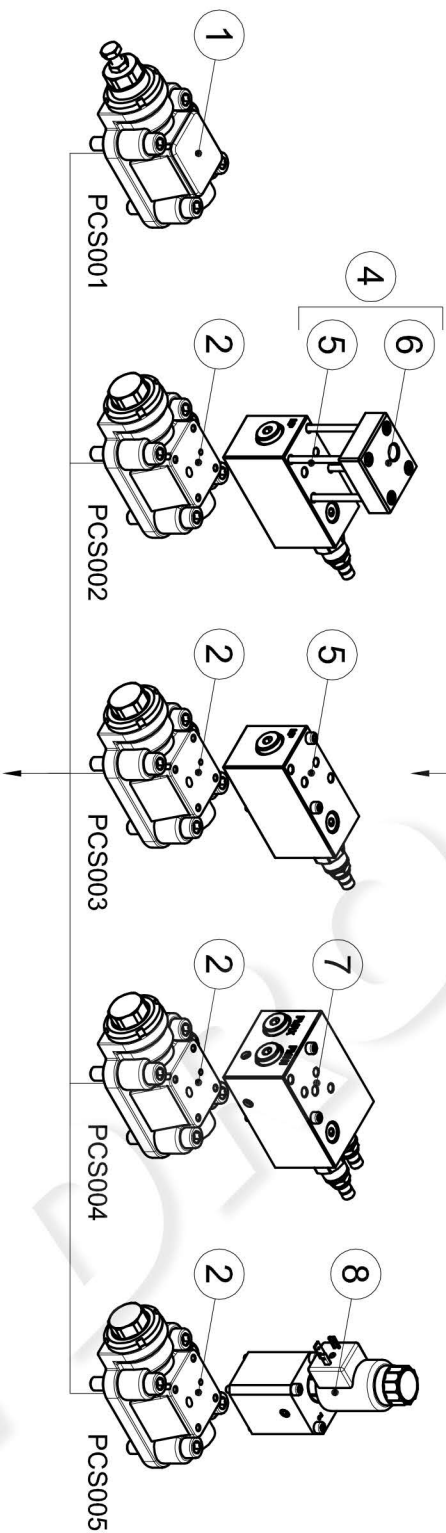

Dopo la trasformazione da un controllo pressione / portata ad un altro occorre sostituire la targhetta della pompa.
 Please remember to change the pump nameplate when you transform to one pressure / flow-rate control to other one.

| N | CODICE CODE |
|----|-------------|
| 1 | 3200010000 |
| 2 | 3200010100 |
| 3 | 3200010200 |
| 4 | 3200010220 |
| 5 | 3200010230 |
| 6 | 3004000200 |
| 7 | 3200010240 |
| 8 | 3200010250 |
| 9 | 3200010310 |
| 10 | 3002502000 |
| 11 | 3200010320 |
| 12 | 3002502500 |
| 13 | 3200010330 |
| 14 | 3200010340 |
| 15 | 3200010350 |

COMPENSATORI INTERCambiabili
 INTERCHANGEABLE COMPENSATORS

POMPA
 PUMP 01 PHV 05

CODICE / CODE

Kit For PVS 05
Cod: 3060005000

In Fase Di Ordine E' Necessario Indicare La Descrizione Completa Della Pompa Sulla Quale Il Kit Verrà Montato.

Berarma Fornisce solo il Kit Completo, NON i Componenti Sciolti.

In Phase Of Order You Must Indicate The Complete Code Of The Pump On Which The Seals Kit Is Mounted.

Berarma Supply Only The Complete Kit, NOT The Single Parts.

Per Guarnizioni In FPM(Viton) Contattare Berarma.

For FPM (Viton) Seals Please Contact Berarma.

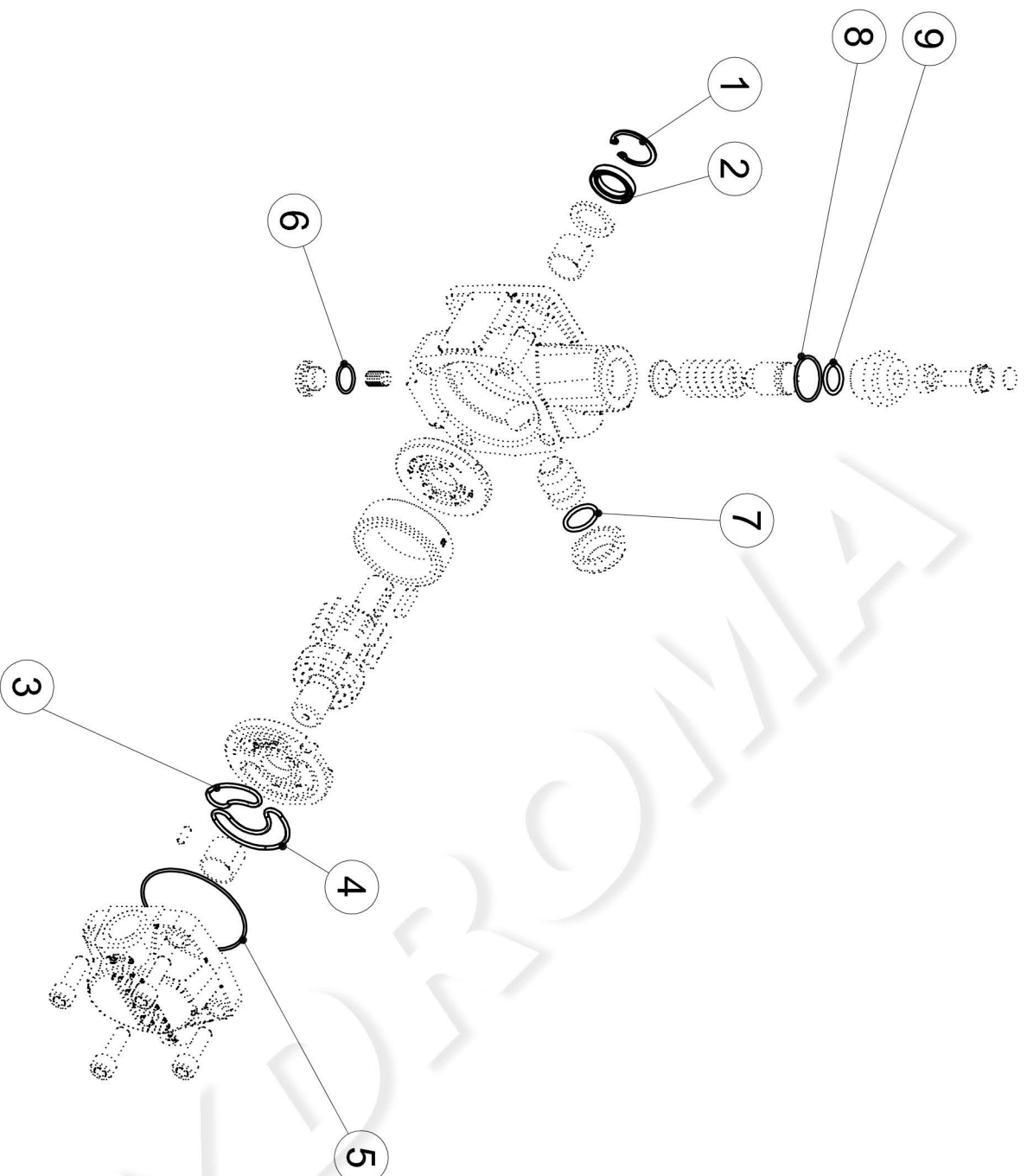

KIT DI GUARNIZIONI - NBR

NBR SEALS KITS

POMPA

PUMP

02 PVS 05

| | |
|----------------------------------------------------------------------------------------------------------------------------------------------------------------------------------------------------------------------------------------------------------------------------------------------------------------------------------------------------------------------------------------------------------------------------------------------------------------------------------------------------------|--|
| CODICE / CODE | |
| <i>Kit For PVS/PSP 1 F</i> | |
| <i>Cod: 3060010000</i> | |
| <p>In Fase Di Ordine E' Necessario Indicare La Descrizione Completa Della Pompa Sulla Quale Il Kit Verrà Montato.</p> <p>Beramma Fornisce solo il Kit Completo, NON i Componenti Sciolti.</p> <p><i>In Phase Of Order You Must Indicate The Complete Code Of The Pump On Which The Seals Kit Is Mounted.</i></p> <p><i>Beramma Supply Only The Complete Kit, NOT The Single Parts.</i></p> <p>Per Guarnizioni In FPM(Viton) Contattare Beramma.</p> <p>For FPM (Viton) Seals Please Contact Beramma.</p> | |

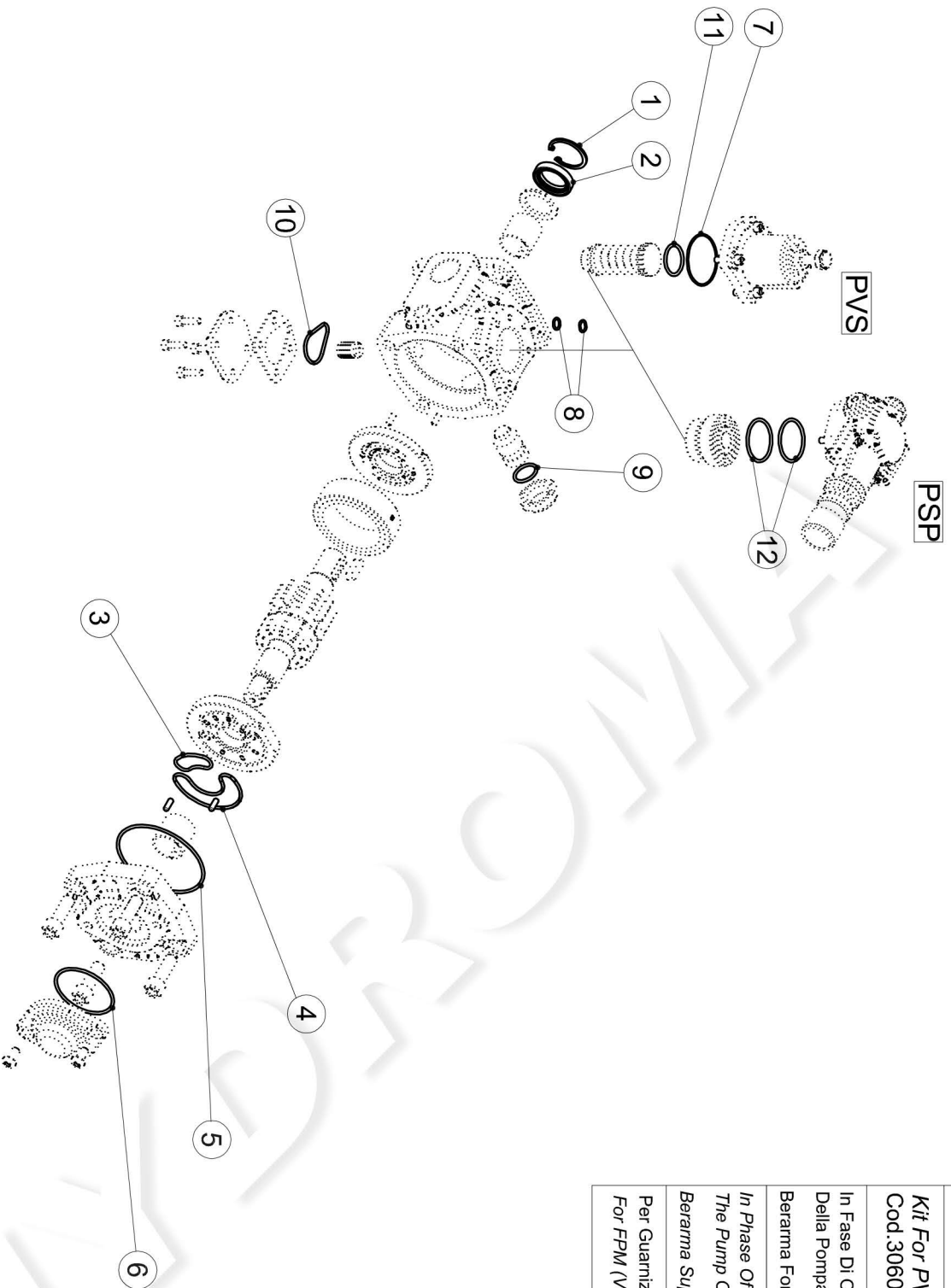

| | |
|---------------------------------|-----------------------|
| KIT DI GUARNIZIONI - NBR | POMPA |
| NBR SEALS KITS | PUMP |
| | 02 PVS PSP 1 F |

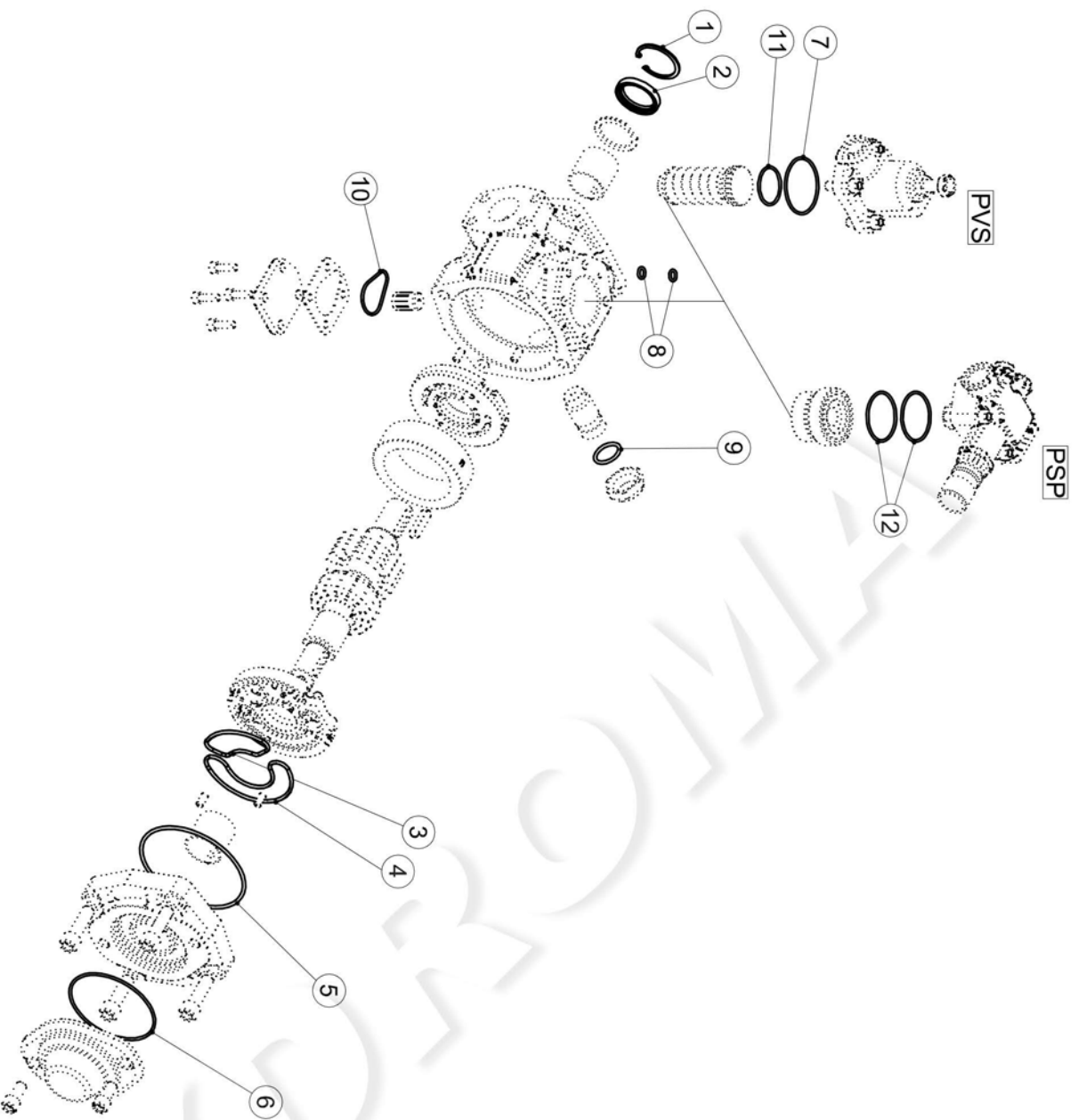

CODICE / CODE

Kit For PVS/PSP 2 F
Cod: 3060020000

In Fase Di Ordine E' Necessario Indicare La Descrizione Completa Della Pompa Sulla Quale Il Kit Verrà Montato.

Beramma Fornisce solo il Kit Completo. NON i Componenti Sciolti.

In Phase Of Order You Must Indicate The Complete Code Of The Pump On Which The Seals Kit Is Mounted.

Beramma Supply Only The Complete Kit, NOT The Single Parts.

Per Guarnizioni In FPM(Viton) Contattare Beramma.
For FPM (Viton) Seals Please Contact Beramma.

KIT DI GUARNIZIONI - NBR
NBR SEALS KITS

POMPA
PUMP

02 PVS PSP 2 F

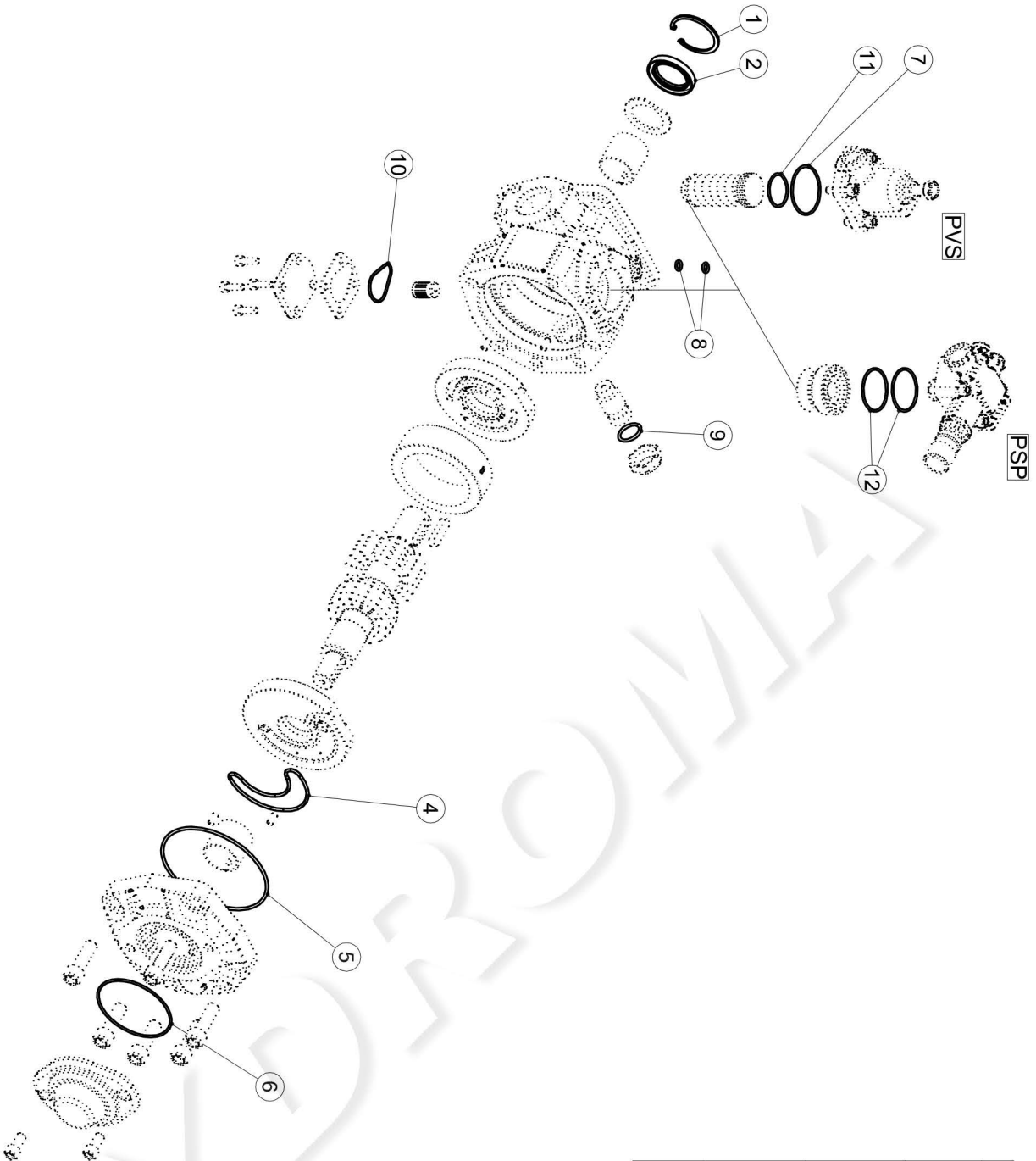

CODICE / CODE

Kit For PVS/PSP 3 F
 Cod: 3060030000

In Fase Di Ordine E' Necessario Indicare La Descrizione Completa Della Pompa Sulla Quale Il Kit Verrà Montato.

Beramma Fornisce solo il Kit Completo, NON i Componenti Sciolti.

In Phase Of Order You Must Indicate The Complete Code Of The Pump On Which The Seals Kit Is Mounted.

Beramma Supply Only The Complete Kit, NOT The Single Parts.

Per Guarnizioni In FPM(Viton) Contattare Beramma.
 For FPM (Viton) Seals Please Contact Beramma.

KIT DI GUARNIZIONI - NBR
NBR SEALS KITS

POMPA
PUMP
02 PVS PSP 3 F

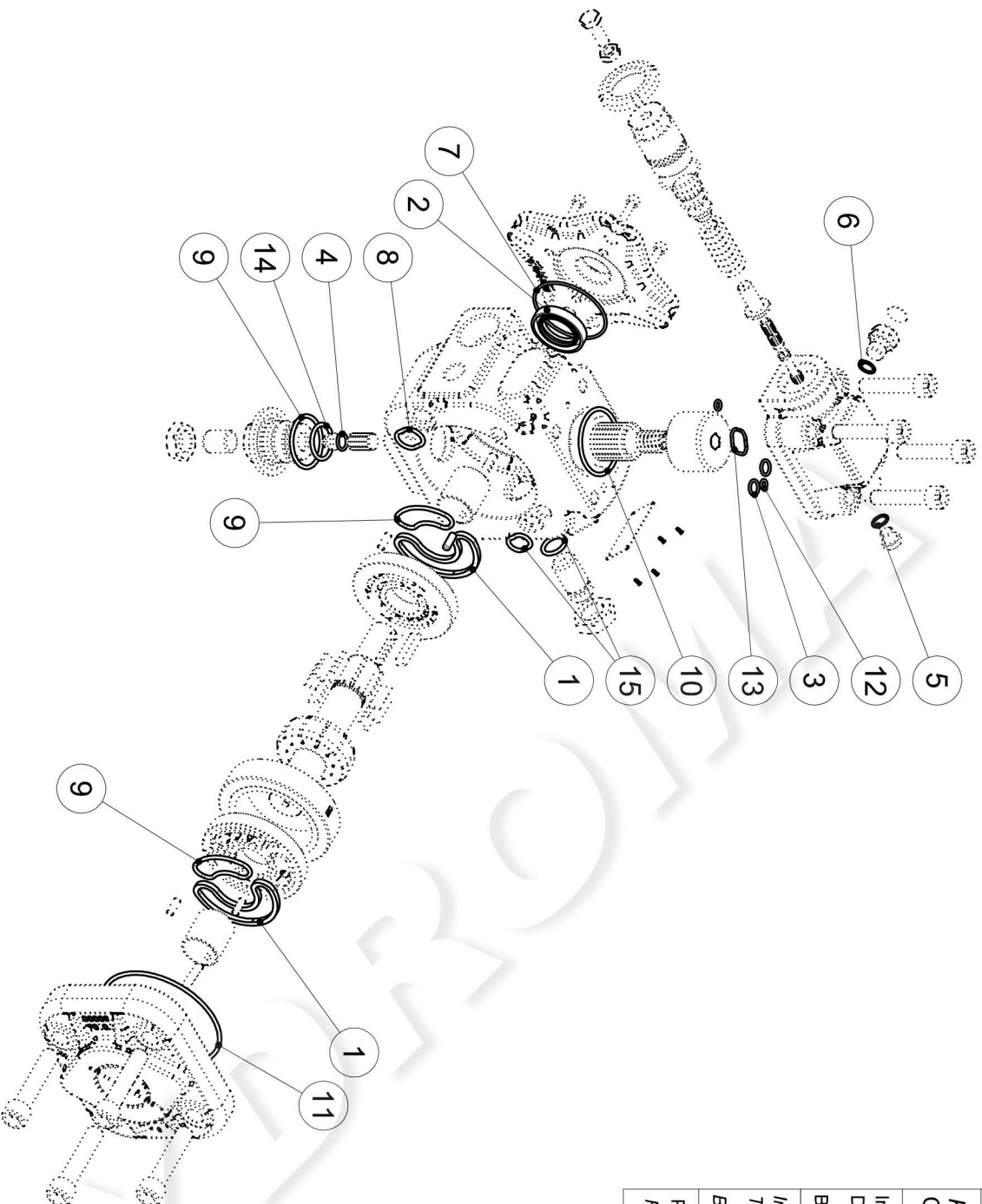

CODICE / CODE

Kit For PHV 05
Cod. 3260005000

In Fase Di Ordine E' Necessario Indicare La Descrizione Completa Della Pompa Sulla Quale Il Kit Verrà Montato.

Berarma Fornisce solo il Kit Completo, NON i Componenti Sciolti.

In Phase Of Order You Must Indicate The Complete Code Of The Pump On Which The Seals Kit Is Mounted.

Berarma Supply Only The Complete Kit, NOT The Single Parts.

Per Guarnizioni In FPM(Viton) Contattare Berarma.
For FPM (Viton) Seals Please Contact Berarma.

KIT DI GUARNIZIONI - NBR

NBR SEALS KITS

POMPA

PUMP

01 PHV 05 ...M

| CODICE / CODE |
|----------------------------------------------------|
| Overhaul Kit For 02 PVS 05 6 F Code 3051005000 |
| Overhaul Kit For 02 PVS 05 10 F Code 3051005100 |
| Overhaul Kit For 02 PVS 05 12 F Code 3051005200 |

In Fase Di Ordine E' Necessario Indicare La Descrizione Completa Della Pompa Sulla Quale Il Kit Verrà Montato.
Berarma Fornisce solo il Kit Completo, NON i Componenti Sciolti.
In Phase Of Order You Must Indicate The Complete Code Of The Pump On Which The Seals Kit Is Mounted.
Berarma Supply Only The Complete Kit, NOT The Single Parts.
Per Guarnizioni In FPM(Viton) Contattare Berarma.
For FPM (Viton) Seals Please Contact Berarma.

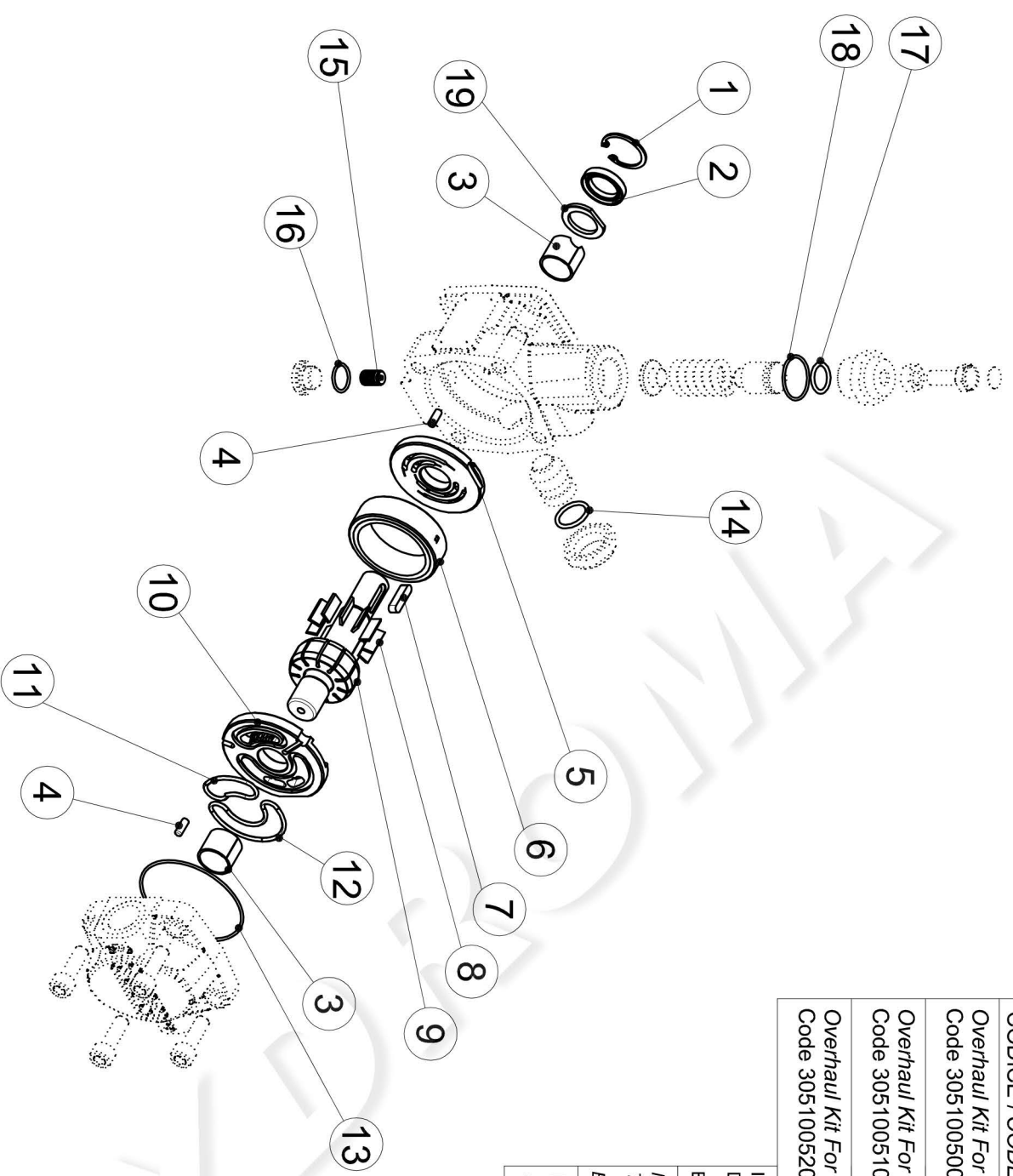

| | | |
|----------------------------------|---------------|-------------|
| KIT DI REVISIONE OVERHAUL KIT | POMPA PUMP | 02 PVS 05 F |
|----------------------------------|---------------|-------------|

| |
|-------------------------------------------------------|
| CODICE / CODE |
| Overhaul Kit For 02 PVS 05 6 FGR2 Code 3051005300 |
| Overhaul Kit For 02 PVS 05 10 FGR2 Code 3051005400 |
| Overhaul Kit For 02 PVS 05 12 FGR2 Code 3051005500 |

In Fase Di Ordine E' Necessario Indicare La Descrizione Completa Della Pompa Sulla Quale Il Kit Verrà Montato.
Beramma Fornisce solo il Kit Completo, NON i Componenti Singoli.
In Phase Of Order You Must Indicate The Complete Code Of The Pump On Which The Seals Kit Is Mounted.
Beramma Supply Only The Complete Kit, NOT The Single Parts.
Per Guarnizioni In FPM(Viton) Contattare Beramma.
For FPM (Viton) Seals Please Contact Beramma.

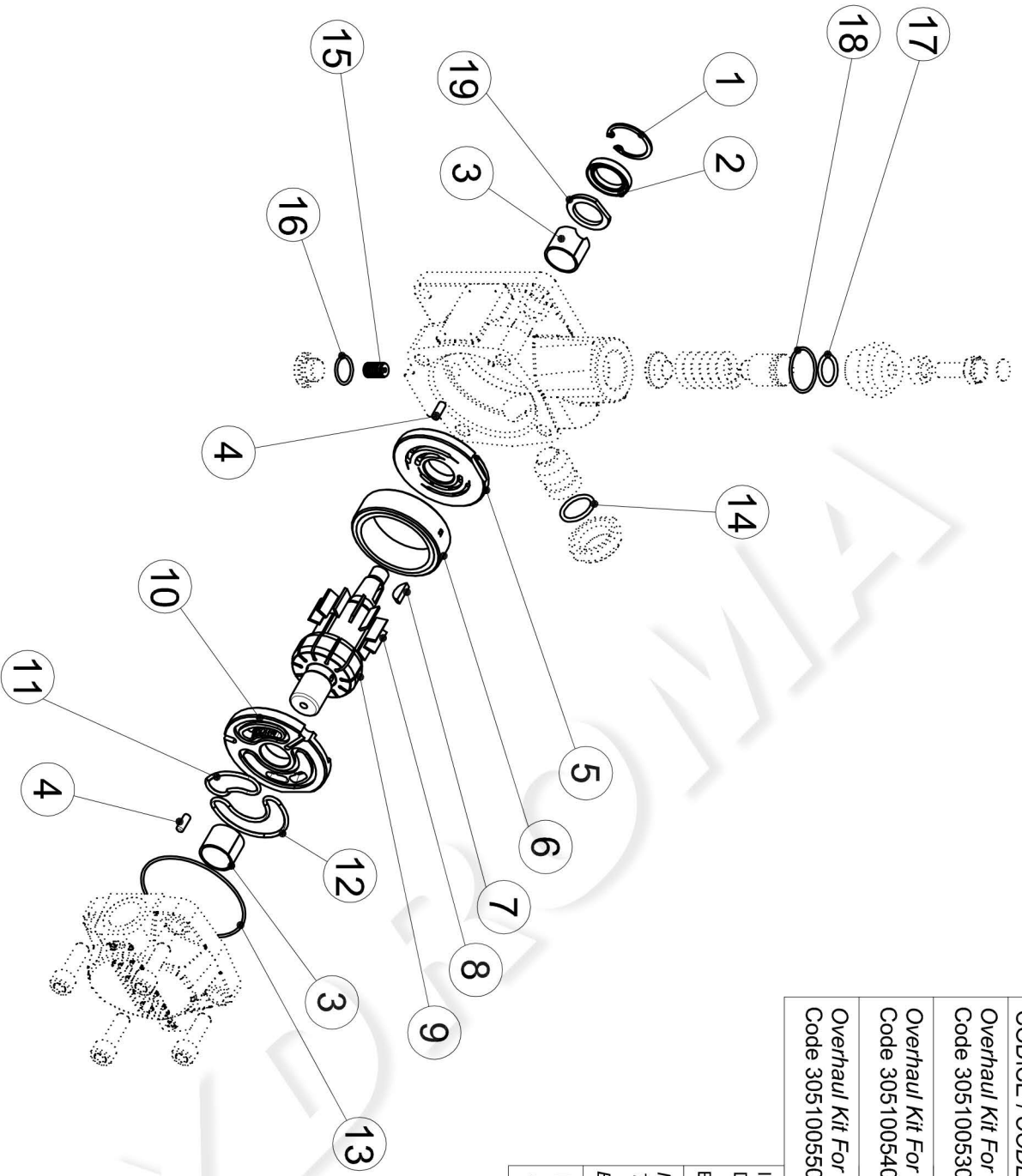

KIT DI REVISIONE
OVERHAUL KIT

POMPA
PUMP
02 PVS 05 FGR2

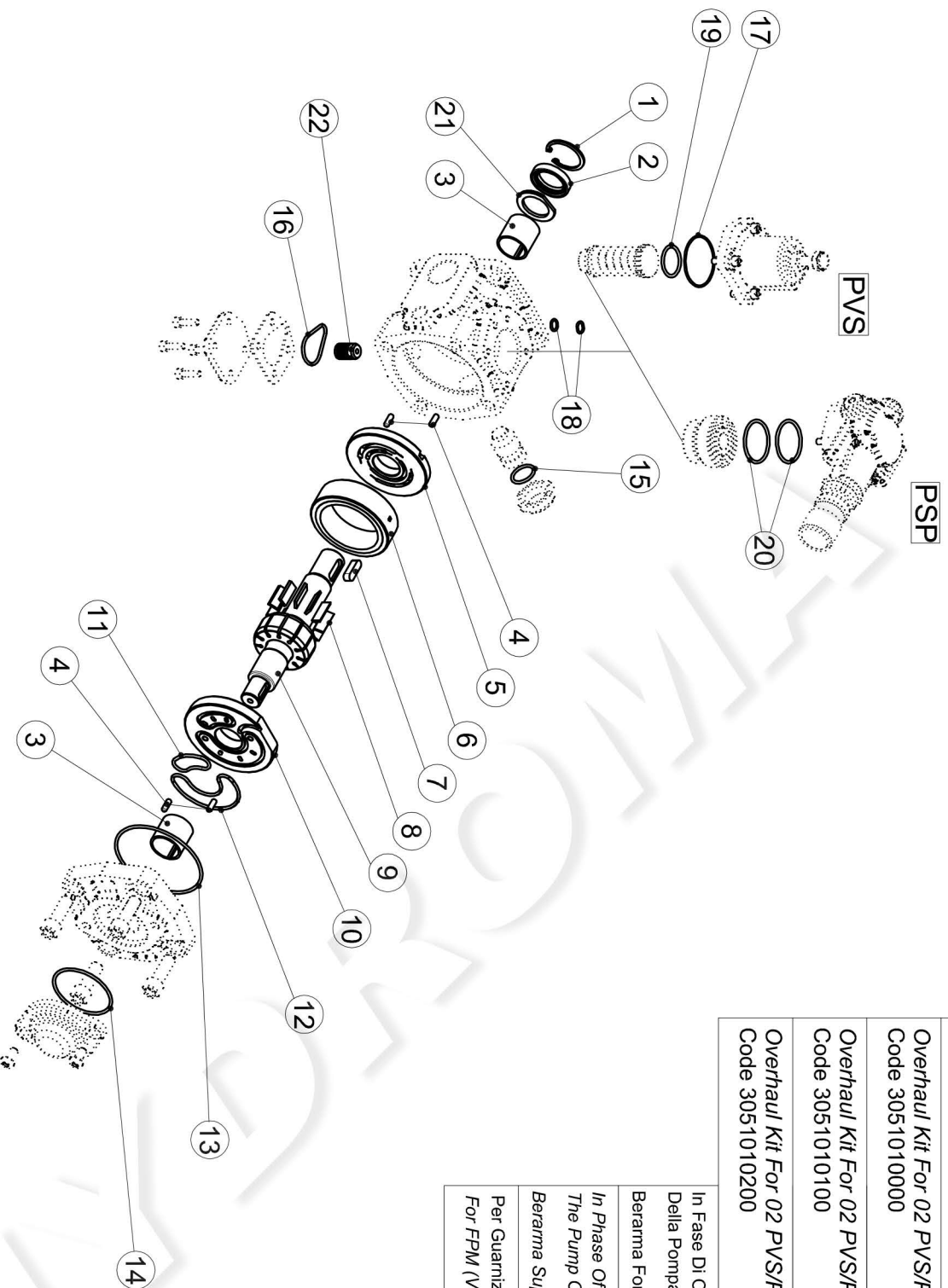

| |
|-------------------------------------------------------|
| CODICE / CODE |
| Overhaul Kit For 02 PVS/PSP 1 16 F Code 3051010000 |
| Overhaul Kit For 02 PVS/PSP 1 20 F Code 3051010100 |
| Overhaul Kit For 02 PVS/PSP 1 25 F Code 3051010200 |

In Fase Di Ordine E' Necessario Indicare La Descrizione Completa Della Pompa Sulla Quale Il Kit Verrà Montato.
Beraroma Fornisce solo il Kit Completo, NON i Componenti Sciolti.
In Phase Of Order You Must Indicate The Complete Code Of The Pump On Which The Seals Kit Is Mounted.
Beraroma Supply Only The Complete Kit, NOT The Single Parts.
Per Guarnizioni In FPM(Viton) Contattare Beraroma.
For FPM (Viton) Seals Please Contact Beraroma.

KIT DI REVISIONE
OVERHAUL KIT

POMPA
PUMP

02 PVS PSP 1 F

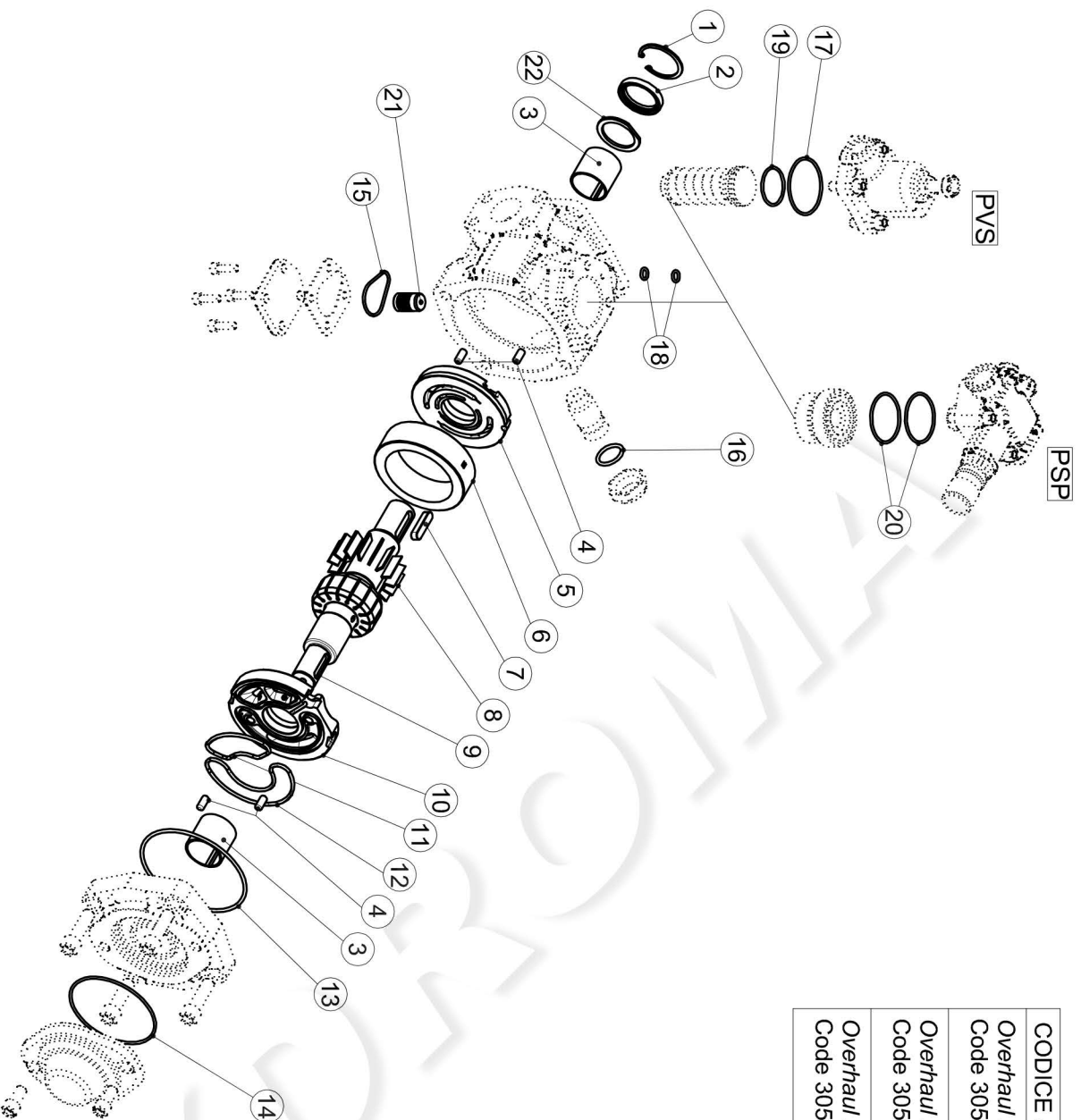

| |
|-------------------------------------------------------|
| CODICE / CODE |
| Overhaul Kit For 02 PVS/PSP 2 31 F Code 3051020000 |
| Overhaul Kit For 02 PVS/PSP 2 40 F Code 3051020100 |
| Overhaul Kit For 02 PVS/PSP 2 50 F Code 3051020200 |

In Fase Di Ordine E' Necessario Indicare La Descrizione Completa Della Pompa Sulla Quale Il Kit Verrà Montato.
Berarma Fornisce solo il Kit Completo, NON i Componenti Sciolti.
In Phase Of Order You Must Indicate The Complete Code Of The Pump On Which The Seals Kit Is Mounted.
Berarma Supply Only The Complete Kit, NOT The Single Parts.
Per Guarnizioni In FPM(Viton) Contattare Berarma.
For FPM (Viton) Seals Please Contact Berarma.

KIT DI REVISIONE
OVERHAUL KIT

POMPA
PUMP

02 PVS PSP 2 F

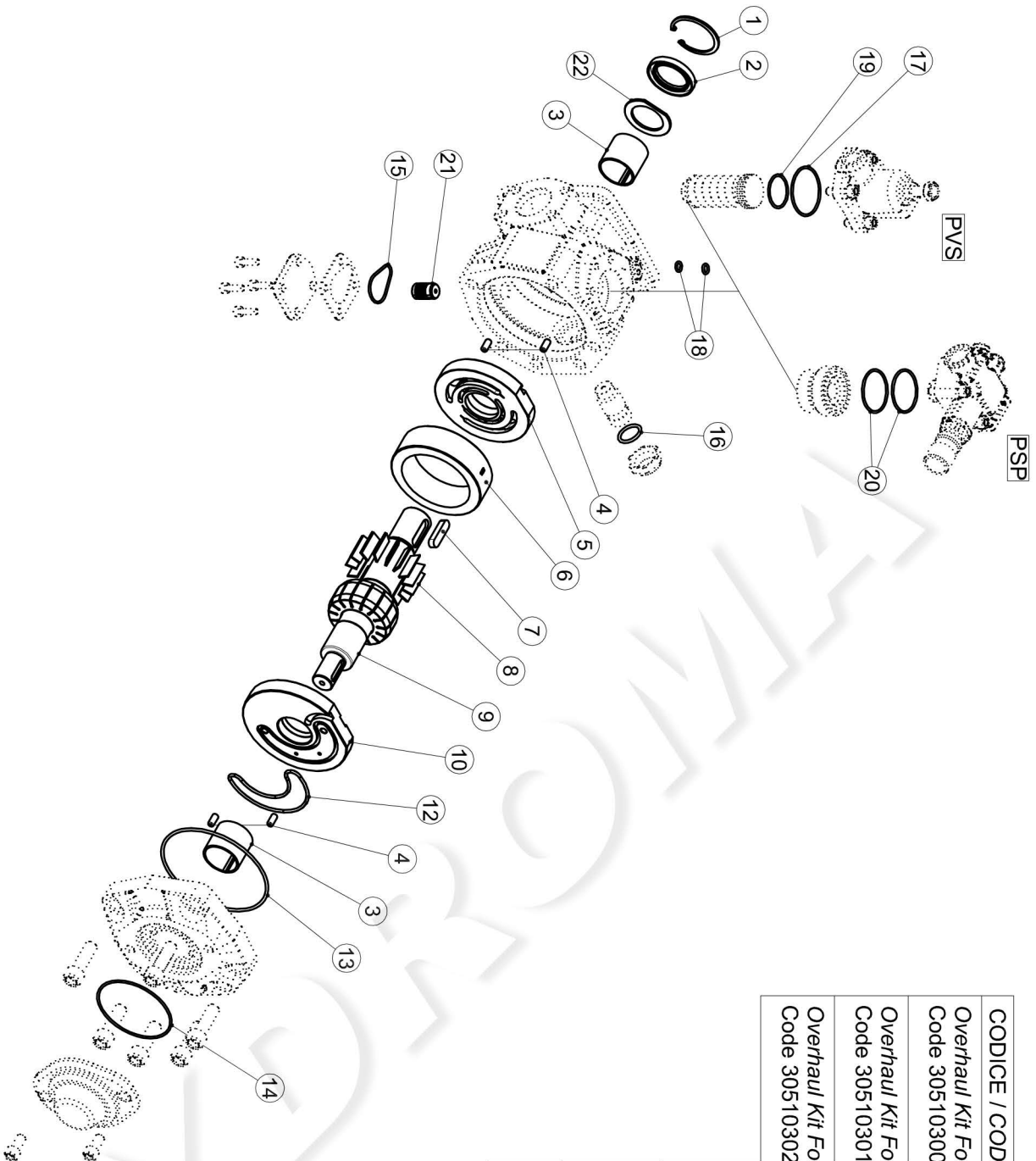

| |
|--------------------------------------------------------|
| CODICE / CODE |
| Overhaul Kit For 02 PVS/PSP 3 63 F Code 3051030000 |
| Overhaul Kit For 02 PVS/PSP 3 80 F Code 3051030100 |
| Overhaul Kit For 02 PVS/PSP 3 100 F Code 3051030200 |

In Fase Di Ordine E' Necessario Indicare La Descrizione Completa Della Pompa Sulla Quale Il Kit Verrà Montato.
Berarria Fornisce solo il Kit Completo, NON i Componenti Sciolti.
In Phase Of Order You Must Indicate The Complete Code Of The Pump On Which The Seals Kit Is Mounted.
Berarria Supply Only The Complete Kit, NOT The Single Parts.
Per Guarnizioni In FPM(Viton) Contattare Berarria.
For FPM (Viton) Seals Please Contact Berarria.

| | | |
|----------------------------------|---------------|----------------|
| KIT DI REVISIONE OVERHAUL KIT | POMPA PUMP | 02 PVS PSP 3 F |
|----------------------------------|---------------|----------------|

CODICE / CODE

Overhaul Kit For 01 PHV 05 F-A
Code 3251005100

In Fase Di Ordine E' Necessario Indicare La Descrizione Completa Della Pompa Sulla Quale Il Kit Verrà Montato.

Berarma Fornisce solo il Kit Completo, NON i Componenti Sciolti.

In Phase Of Order You Must Indicate The Complete Code Of The Pump On Which The Seals Kit Is Mounted.

Berarma Supply Only The Complete Kit, NOT The Single Parts.

Per Guarnizioni In FPM(Viton) Contattare Berarma.
For FPM (Viton) Seals Please Contact Berarma.

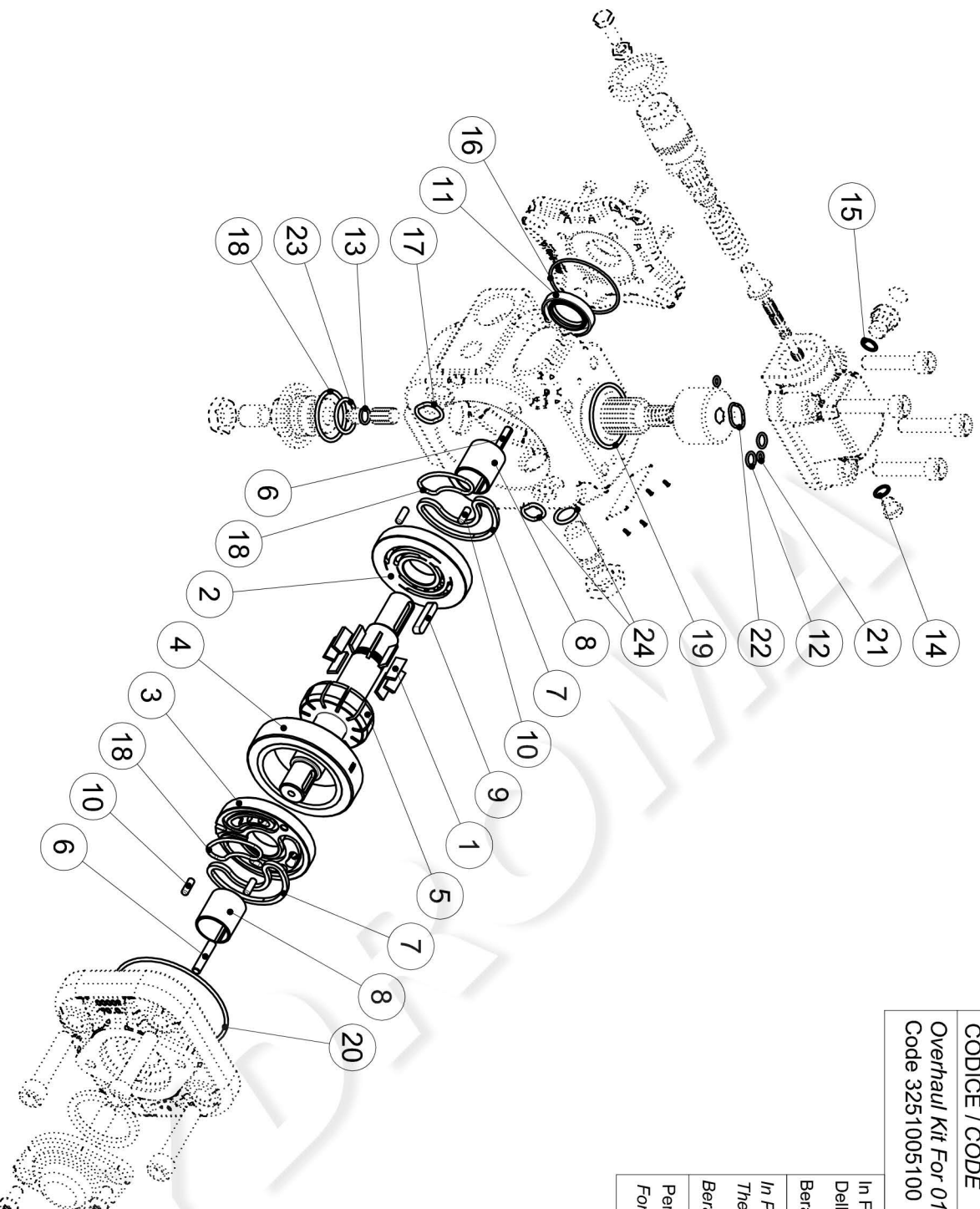

KIT DI REVISIONE
OVERHAUL KIT

POMPA
PUMP

01 PHV 05 F-A

CODICE / CODE

Overhaul Kit For 01 PHV 05 FGR2
Code 3251005200

In Fase Di Ordine E' Necessario Indicare La Descrizione Completa Della Pompa Sulla Quale Il Kit Verrà Montato.

Beramma Fornisce solo il Kit Completo. NON i Componenti Sciolti.

In Phase Of Order You Must Indicate The Complete Code Of The Pump On Which The Seals Kit Is Mounted.

Beramma Supply Only The Complete Kit. NOT The Single Parts.

Per Guarnizioni In FPM(Viton) Contattare Beramma.

For FPM (Viton) Seals Please Contact Beramma.

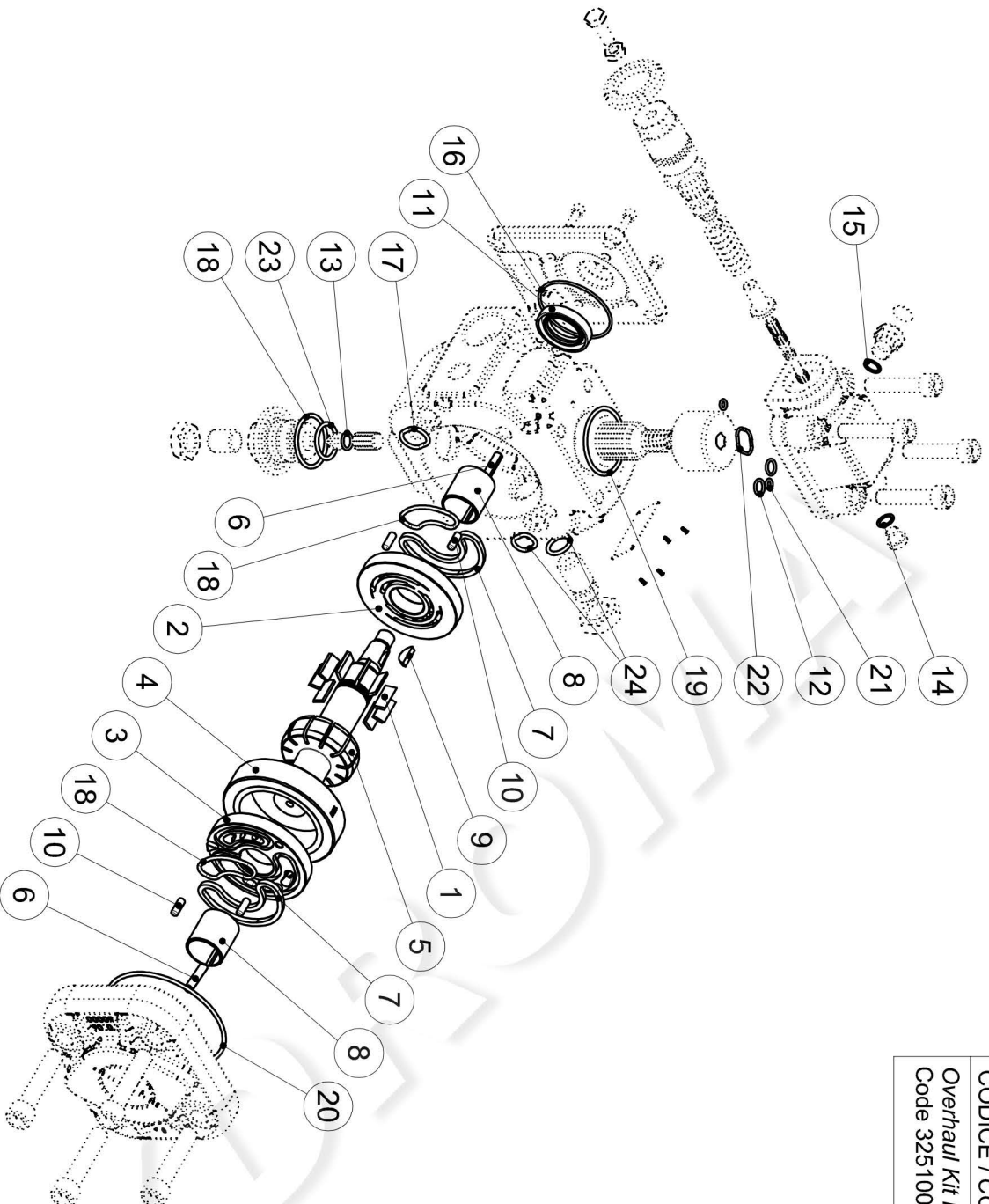

KIT DI REVISIONE

OVERHAUL KIT

POMPA

PUMP

01 PHV 05 FGR2

CODICE / CODE

Overhaul Kit For 01 PHV 05 FGR2-A
Code 3251005300

In Fase Di Ordine E' Necessario Indicare La Descrizione Completa Della Pompa Sulla Quale Il Kit Verrà Montato.

Beramma Fornisce solo il Kit Completo, NON i Componenti Sciolti.

In Phase Of Order You Must Indicate The Complete Code Of The Pump On Which The Seals Kit Is Mounted.

Beramma Supply Only The Complete Kit, NOT The Single Parts.

Per Guarnizioni In FPM(Viton) Contattare Beramma.
For FPM (Viton) Seals Please Contact Beramma.

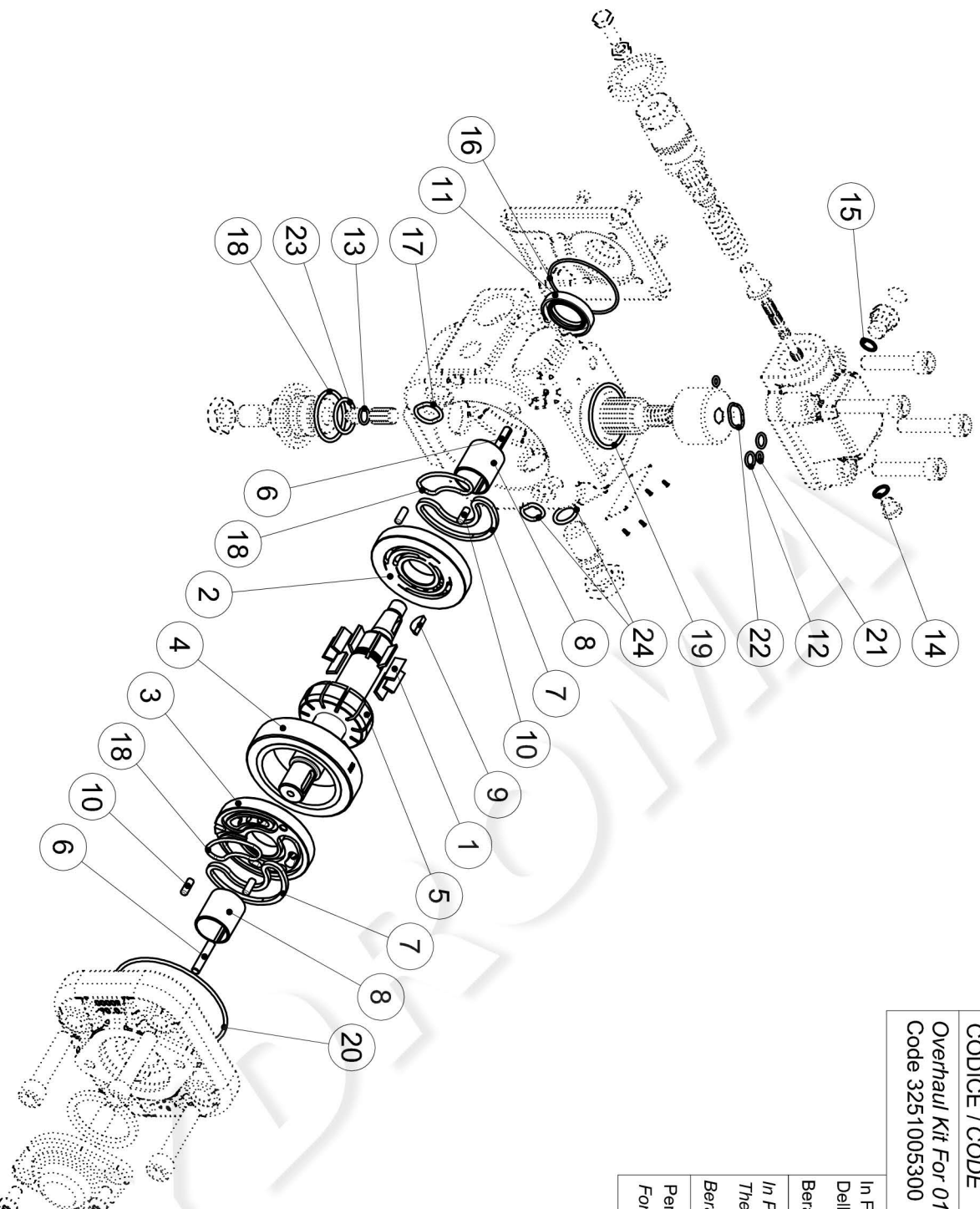

KIT DI REVISIONE
OVERHAUL KIT

POMPA
PUMP
01 PHV 05 FGR2-A